

L2 Series Software - Automation Builder Option for Use with Test Builder Application

User's Guide



Starrett®

The Better Solution



Table of Contents

	Page
1.0 Introduction	5
2.0 Using the Automation Builder	5
2.1 Test Builder Application	5
2.1.1 Tension (Pull) Steps	5
2.1.2 Compression (Push) Steps	5
2.1.3 Hold Steps	5
3.0 Using Formulas	6
3.1 Defining Your Variable	6
3.1.1 Creating Your Formula	6
3.1.2 Selecting Coefficients	7
3.1.3 Numeric Keypad & Operators	7
3.2 Formula Examples	7
3.2.1 Percentage % Elongation	7
4.0 Using I/O	13
4.1 I/O Schematic	13
4.2 I/O Line Settings	13
4.3 Move To Inputs	14
4.3.1 Using Tension/Pull Input	14
4.3.2 Using Compression/Push Input	14
4.4 Outputs	15
5.0 Using Conditional Branching	16
5.1 IF Step	16
5.1.1 Formula Condition	16
5.1.2 True and False Conditions	16
5.2 ELSE Step	16
5.3 END Step	17
5.4 Conditional Branching Example	17

General Safety Precautions

Force measurement systems are potentially hazardous. Prior to operating your testing system, Starrett recommends that you read and understand the instruction manuals for your system and components and that you receive training on the proper use of this equipment from your authorized Starrett representative.

Observe all warnings and cautions identified in this manual for your equipment. A **warning** identifies a function that may lead to injury or death. A **caution** identifies a hazard that may lead to damage to equipment or loss of data.

Starrett products, to the best of our knowledge, comply with various national and international safety standards as they apply to material and force measurement testing. This Starrett product has been tested and found to comply with the following recognized standards:

- EN61010-1 Safety Requirements for Electrical Equipment
- EN61000-6-3 EMC Generic Emissions Standard
- EN61000-6-1 EMC Generic Immunity Standard

Starrett also certifies that this product complies with all relevant EU directives and carries the CE mark.

Warnings

Testing of springs is inherently dangerous.

Always make sure to properly secure the spring being tested. And always wear appropriate eye protection whenever testing any material that may fracture during a testing procedure.

Emergency Stop

Press the emergency stop button whenever you feel there is an unsafe condition during a test. The emergency stop button removes power to the motor drive system causing the crosshead to stop.

Flying Debris

Eye protection, protective clothing and splinter/safety shields should be used whenever any possibility exists of a hazard from the failure of a sample, assembly or structure under test. Due to the wide range of materials that may be tested and that may result in a failure and could result in bodily injury, the precautions and preventative methods taken prior to testing is entirely the responsibility of the owner and the user of the equipment.

Crush Hazard

Always use caution when installing or removing apparatus and your sample material between the frame's crosshead and the base. A potential pinch/crush hazard exists. Keep clear of the testing fixture, and particularly the jaw faces at all times. Keep clear of the crosshead during movement. Always make sure the Pinch Load feature is enabled, which will stop and inadvertent crosshead operation if in manual mode. Always ensure that other personnel cannot operate the system while you are working within the test fixture area.

Electrical Hazard

- Disconnect equipment from the electrical power supply before removing any electrical safety covers.
- Disconnect power when replacing fuses.
- Never reconnect power while the covers are removed.
- Never operate the system with protective covers removed.

Rotating Machinery Hazard

Always disconnect power before removing covers that protect the user from the internal rotating mechanisms. If maintenance to the drive mechanism is required, and power is needed to perform maintenance to the drive system, maintenance should be performed by an authorized Starrett representative who has received factory training on performing such procedures.

1.0 Introduction

Thank you and congratulations for selecting the optional Starrett L2 Automation Builder software for use with your Starrett FMS/SMS Series testing machines.

2.0 Using the Automation Builder

The L2 Automation Builder is an optional software package that requires the L2 Test Builder application. The Automation Builder software enhances the functionality provided by the Test Builder by supplying you with:

- Formulas
- Input/Output
- Conditional Branching

You can create formulas that use your basic results to determine more advanced force measurement and material testing results including percentage % elongation, work, stress, strain, maximum shear strength, tensile strength, etc.

Your FMS/SMS test frames are equipped with a 12-channel I/O connector that you can use for inputs and outputs to/from ancillary equipment. Many types of digital input/output signals from switch closures, relay contacts, or TTL-compatible interfaces can be used with your FMS/SMS Series testing systems. For example, you can determine the minimum load necessary to make/break an electrical contact.

You can use conditional branching and develop logical IF-THEN statements that can be used with the I/O functionality in a factory automation cell. For example, conditional branching can be used where the result of a test can be used to control conveyors that separate “passed product” from “failed product”.

Starrett can provide system integration services that will integrate your factory equipment with your testing system to help you achieve increases in production yields and efficiency.

The L2 Test Builder combined with the Automation Builder gives you significant testing and automated control functionality that expands the capability of your testing system.

2.1 Test Builder Application





The Test Builder application lets you create any type of test for your FMS/SMS Series systems. The Test Builder is especially useful for complex and multi-step test methods. It can also be used to create test procedures that follow international testing standard procedures from ASTM, DIN, ISO and others.

With the Test Builder application, you create your test setup using combinations of steps that control the direction, duration and velocity of your tester’s crosshead. Loads, distances and heights are measured and reported. The steps supplied with the Test Builder application that make use of the Automation Builder option are the Tension, Compression and Hold steps.

2.1.1 Tension (Pull) Steps

The Test Builder supports a number of tension (pull) steps. These steps are used when pulling the sample. When the Automation Builder option is used, there is a tension step that can be used to measure the load until an event occurs, e.g. switch opens/closes.





Tension (Pull) Steps

	Home: Used to return to the Home position prior to, during or at the completion of a test.
	Load Limit: Used to pull the sample to a Load target.
	Distance Limit: Used to pull the sample to a Distance target.
	Break Limit: Used to pull the sample until a Break event has occurred.
	Digital Input: Used to pull the sample until a digital input has occurred. This step type appears only with Automation Builder.

2.1.2 Compression (Push) Steps

The Test Builder supports a number of compression (push) steps. These steps are used when pushing the sample. When the Automation Builder option is used, there is a compression step that can be used to measure the load until an event occurs, e.g. switch opens/closes.

Compression (Push) Steps





	Home: Used to return to the Home position prior to, during or at the completion of a test.
	Load Limit: Used to push the sample to a Load target.
	Distance Limit: Used to push the sample to a Distance target.
	Break Limit: Used to push the sample until a Break event has occurred.
	Digital Input: Used to push the sample until a digital input has occurred. This step type appears only with Automation Builder.

2.1.3 Hold Steps

There are two types of hold steps. You may hold at a load or hold at a distance/height. When the Automation Builder option is used, you can hold at a load or a distance until an event occurs.

For more detailed information on the Test Builder, please read the *Test Builder User Guide*.

Hold Steps

	Load Hold: Used to return to the Home position prior to, during or at the completion of a test.
	Distance Hold: Used to push the sample to a Load target.
	Digital Input: Hold the sample at a target Load until a digital input has occurred. This step type appears only with Automation Builder.
	Digital Input: Hold the sample at a target Distance until a digital input has occurred. This step type appears only with Automation Builder.

3.0 Using Formulas

The Automation Builder lets you create arithmetic formulas that allow you to calculate results typically used in material testing, or for more advanced force measurement.

You create a formula using the standard coefficients available with the Test Builder Data Step. The Data Step is where you select the data elements or coefficients that represent your measurements. Before a formula can be created, the coefficients must first be specified for your test setup.

3.1 Defining Your Variable

The variable is the name you give to the result of your formula.

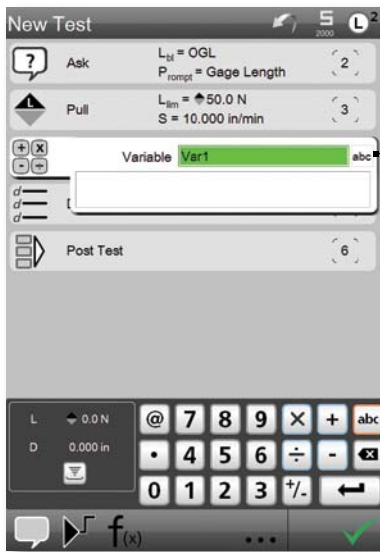

The Variable Name is the name you give to the new coefficient.

Note that before your formula can be created, you must have already specified the coefficients (results) that are being reported.

The formula block is defined below the Variable Name.



3.1.1 Creating Your Formula

You must define the coefficients you want to measure and report BEFORE you can create the formula. These coefficients will serve as the values used in your formula.

With the formula box displayed, select the L,D key on your virtual keypad. This will display the coefficients that have been selected for your test.

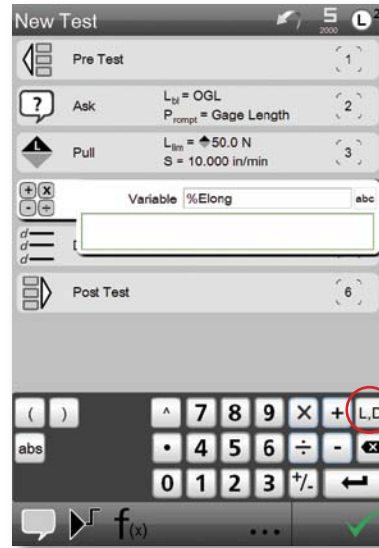

Select the L,D key to view the coefficients you can use in your formula.

Each coefficient that you select appears once the L,D key is pressed. Press the coefficients you want to use in the formula. Once a coefficient is pressed, it will appear in the formula block.

The coefficients selected are shown in the formula block. The red line around the formula block shows that the block is active.

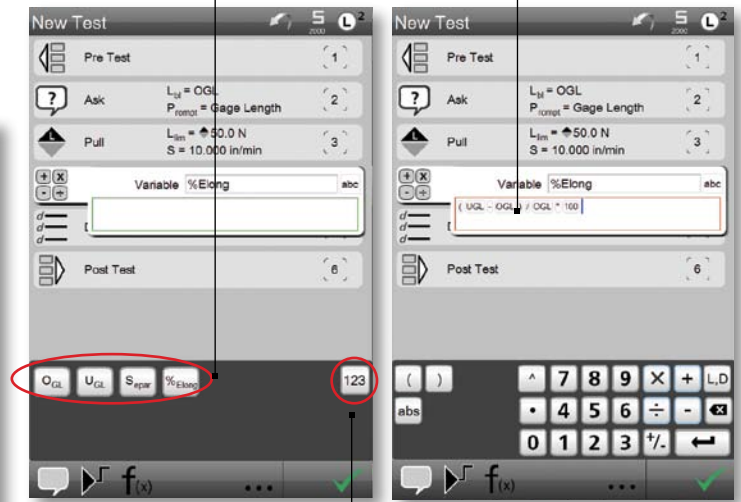

Select the 123 key to view the main numeric keypad with operators.

3.1.2 Selecting Coefficients

Select the coefficients that will appear in your formula. The coefficients should be selected based on the formula that you intend to create.



Do NOT USE brackets for multiplication. Use the X operator for multiplication.

Use these common operators for multiply, divide, addition and subtraction.

Use the operators for Distributive Law formulas (brackets).

Do NOT USE in formulas.

Use the 'abs' (absolute) operator where you want the result of your formula to yield a positive result.

3.1.3 Numeric Keypad & Operators

Use the L,D and 123 keys to create the formula. The L,D key is used to access the available coefficients. The 123 key is used to access the mathematical operators and numeric keys.

Use the selected coefficients in the formula. Access the available coefficients using the L,D key.

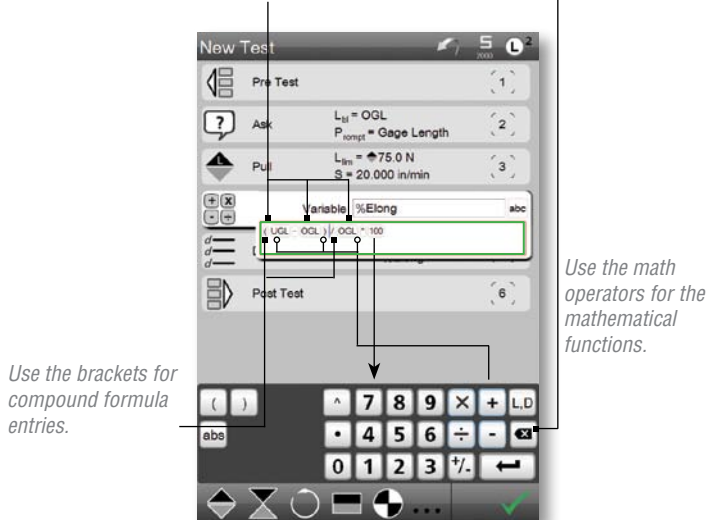

Use the brackets for compound formula entries.

Use the math operators for the mathematical functions.

Use the numbers for other calculators, e.g. x 100 to express %.

3.2 Formula Examples

This section will describe some examples of commonly used results and how these results can be created using formulas.

3.2.1 Percentage % Elongation

Finding the % elongation of tubing or other materials is based on the change in length from the original gage length of the sample compared to the ultimate gage length.

In this example, we know the original gage length of the sample based on the drawing/specification. We use an ASK step as our first test step in our test setup. The ASK step is renamed "OGL" for Original Gage Length, and requires the operator to enter the numeric value.

The next step requires us to determine the Ultimate Gage Length (UGL). There are a number of ways to determine the UGL: pull the sample to break and determine the distance at peak load; specify a load limit target; and determine the distance at the load target. We use the distance at the load target in our example.

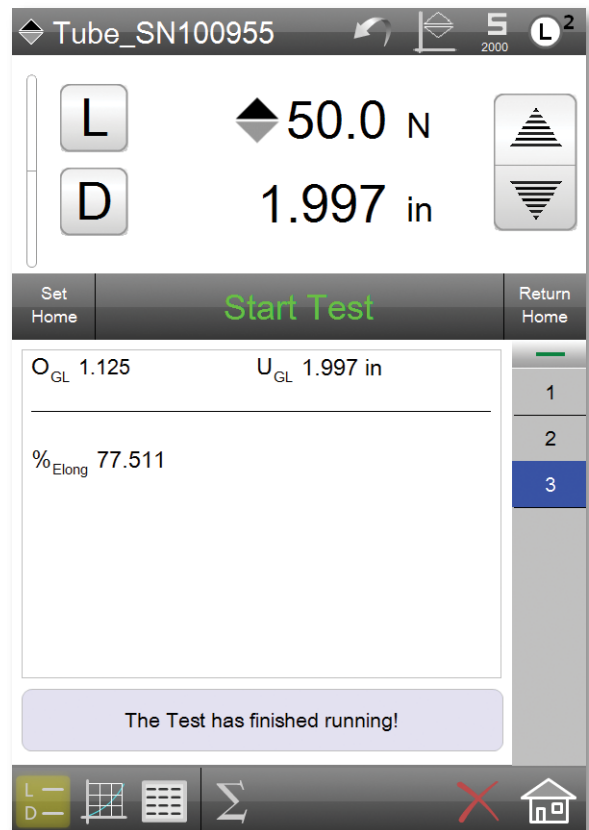

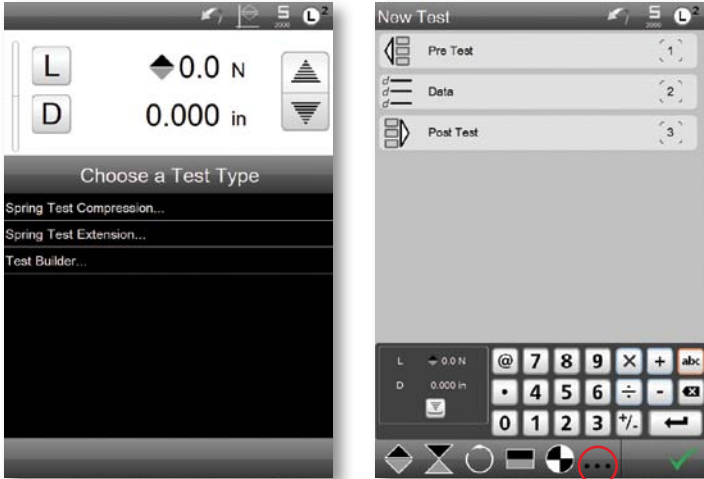

Create a New Test.

Use the Test Builder to create your new test setup.

- Select Test Builder.
- No Changes to Pre or Post Test options. Leave factory defaults.

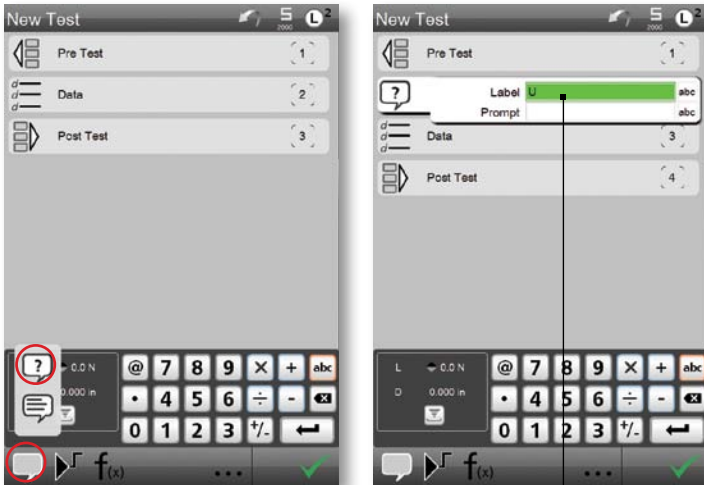

The default label is U (coefficient). Change the label to read "OGL" to represent Original Gage Length.

Create a User Prompt (Ask).

Use the Test Builder to create your new test setup.

- Select the ... to access the Ask step.
- Select the Ask option that requires an operator response to the prompt.

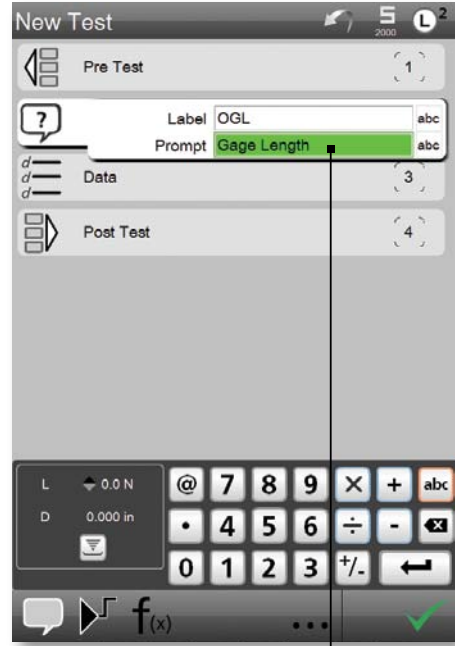

Enter what you want to display when the prompt is displayed. Use "Gage Length" to alert the operator to enter the original gage length of the sample prior to stretching.

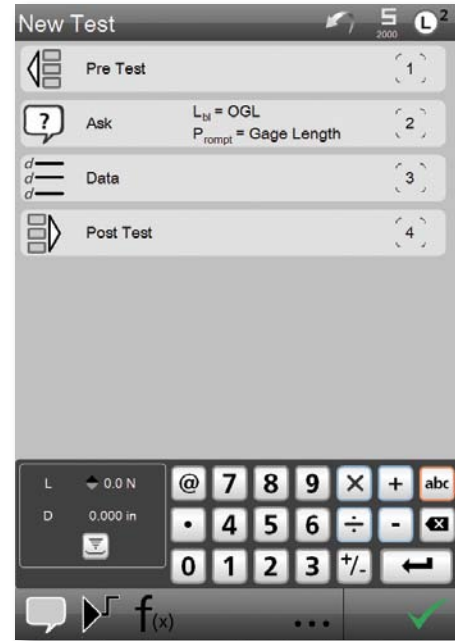

Enter the Prompt Name.

Specify the prompt that you want displayed to the operator during the test.

- Select the Label field and rename to OGL (Original Gage Length).
- Select the Prompt field and rename to "Gage Length".

Because you entered an Ask prompt, when "Gage Length" is displayed during the test, the operator is required to enter the original Gage Length measurement. This might be measured using a print of the part or using a digital micrometer or ruler.

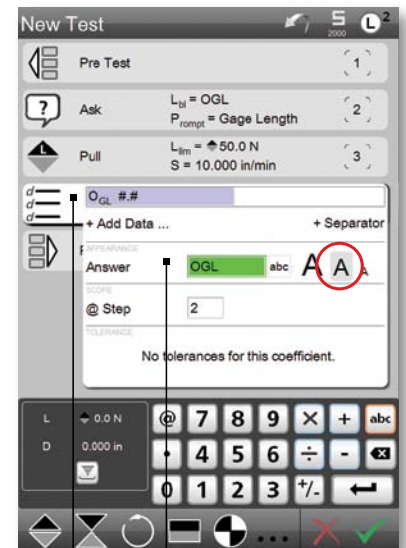
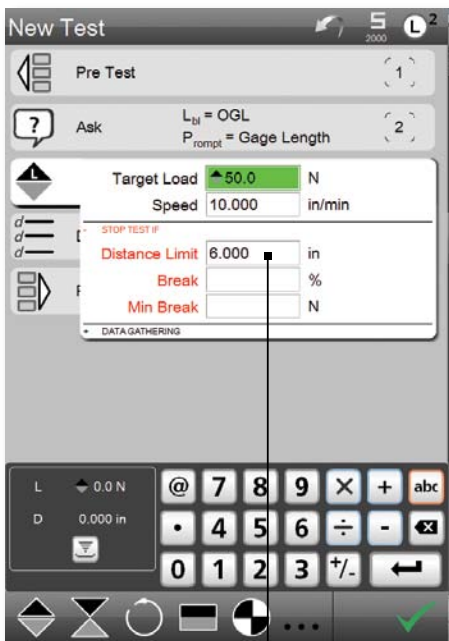
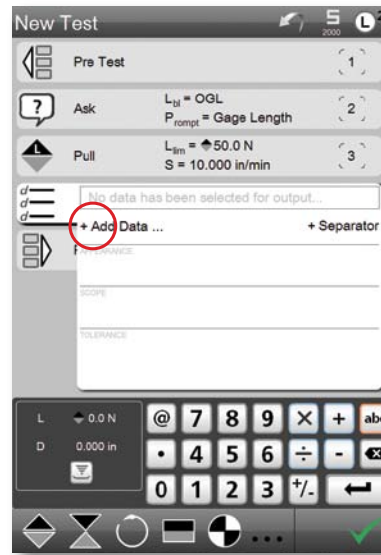
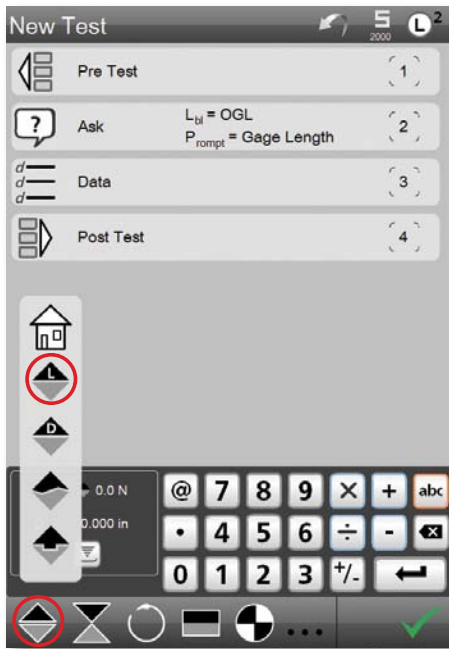

Enter an exception for Distance.

If the crosshead moves to this distance, abort the test.

Select the coefficient and format in a two-column manner using the middle A.

Rename the ANS coefficient to read OGL to represent Original Gage Length- the user response to the prompt.

Enter the tension Load step.

Enter the target load limit to which you want to pull the sample.

- Select the Tension step and select the Load target option.
- Enter the target load limit of 50.0N and the test speed velocity of 10 in/min.
- Select the Exception option.
- Enter the Distance exception of 6.000 inches.

Because an exception on Distance is used, if the crosshead moves to a tension distance of 6 inches, the test will automatically abort.

Select the Data (Coefficients) you want to report.

Select, rename, and format the coefficients you want to use to express the % elongation result.

- Select the Data step.
- Select the + Add Data ... to display the coefficient list.
- Select the ANS (Answer) coefficient used to represent the "answer to your prompt" called "Gage Length".
- Rename the ANS coefficient to OGL to represent Original Gage Length.
- Select the middle A to use a twin column format. This reduces the text size to the medium size.

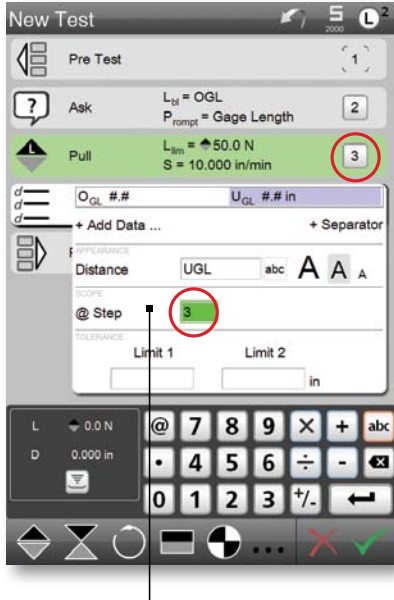

Rename the Distance (D) coefficient to UGL to represent Ultimate Gage Length. Note this coefficient is associated with Step 3.



Select ... to access additional step types.

Select the Distance (D) for step 3, your Load target of 50.0N.

Select the Distance (D) coefficient to measure the distance at the load target of 50.0N. This represents the ultimate gage length- the length at the target load limit.

- Select the Data step.
- Select the + Add Data ... to display the coefficient list.
- Select the Distance (D) coefficient. This is the measured length of the sample at the 50.0N target load limit.
- Rename the Distance (D) coefficient to UGL to represent Ultimate Gage Length.
- Select the middle A to use a twin column format. This reduces the text size to the medium size. This will appear next to the OGL coefficient.



Select the Formula step type option.



Enter the new name for the variable. The variable is the coefficient that will be determined based on your formula.

Add a Formula to your setup.

Select f(x) step to create the formula to calculate the percentage % elongation result.

- Select the f(x) step.
- Select the Formula symbol. This adds a formula step.

This is the formula block where you will create your formula.



Enter the new name for the variable. The variable is the coefficient that will be determined based on your formula.

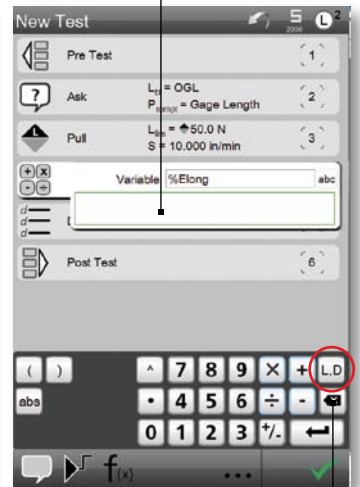

Use the L,D target to access your coefficients. Use the virtual keypad to enter your formula operators.

Create a new Coefficient to represent % Elongation.

Select the Variable block and change Var1 to read % Elong.

- Select the Var 1 text block.
- Enter the Variable name. Our variable will be called %Elong to represent the calculated variable % elongation.

Important: Use the virtual numeric keypad to create your formula and NOT an attached keyboard.

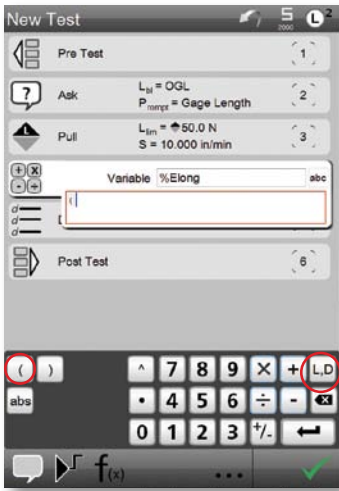

Use the operators to create the formula.

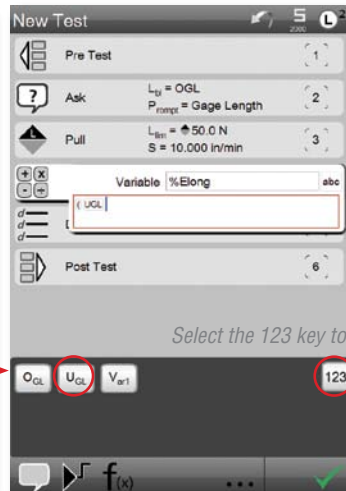

Select the L,D key to display the available coefficients on which to create the formula.

Select the 123 key to return to the main operator view.

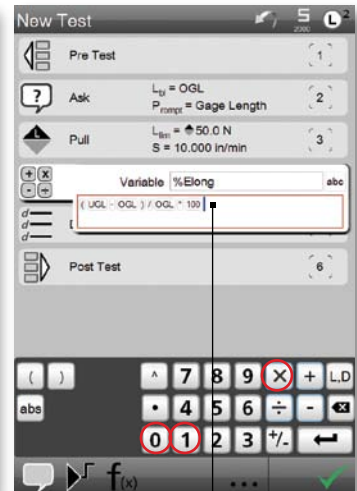

Enter the value "100" to create a percentage.

Create your Formula for Percentage % Elongation.

The formula is created using the coefficient you have selected already in your Data step combined with the mathematical operators found on your numeric keypad.

Percentage % Elongation is found using the following formula:

$$\text{Percentage \% Elongation} = (\text{UGL} - \text{OGL}) / \text{OGL} \times 100$$

where:

UGL = Ultimate Gage Length

OGL = Original Gage Length

Use the L,D key and the 123 key to navigate to your coefficients and operators.

- Select the open bracket (.
- Select the L,D key to display the available coefficients.
- Select UGL. Select the 123 key to return back to the main operators.
- Select the subtraction operator (-).
- Select L,D key and select the OGL coefficient.
- Select the 123 key to return back to the operators.
- Select the closed bracket).
- Select the divide operator.
- Select the multiply operator.
- Enter the value 100. This will convert your decimal result to a percent.

Select the "move back" arrow to completely erase the test setup.

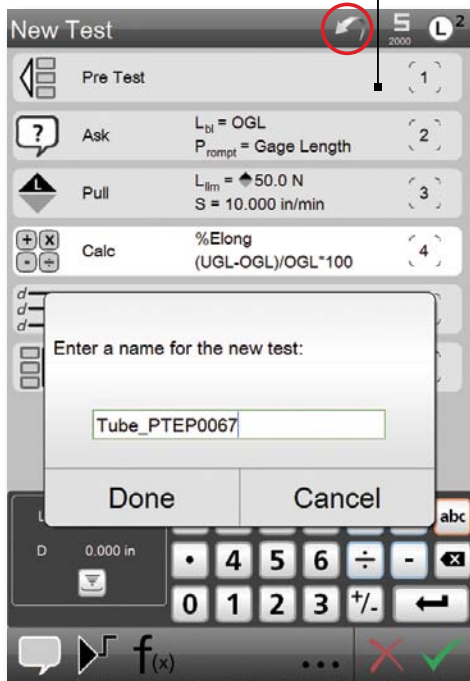

Name your Test Setup.

All tests must have a name. This name identifies the test setup on the main menu page.

- Select the checkmark.
- Enter the Test Name using a keyboard.
- Select Done.

If you want to totally abort this test and cancel this setup, select the "move back" arrow on the top status line.

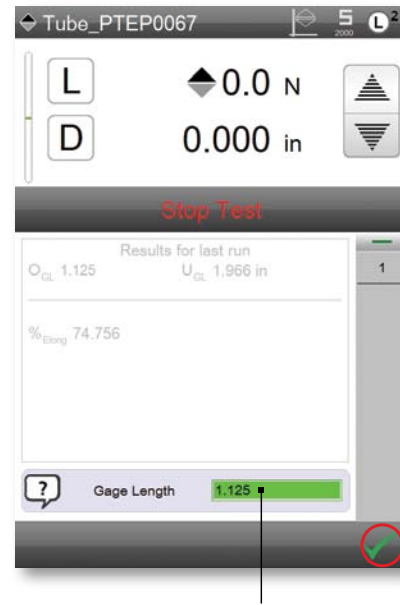

The prompt is asking the operator for a response to the Gage length.

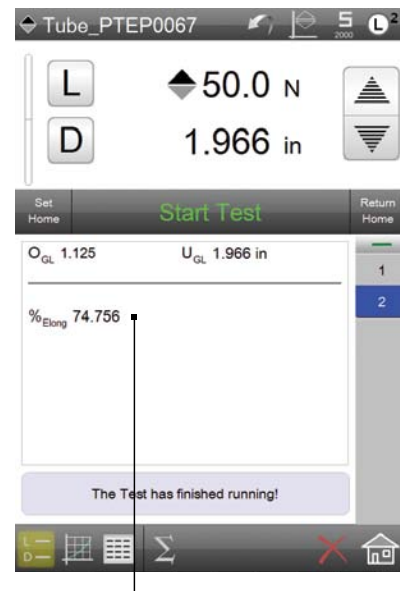

The % elongation is determined to be 74.756%.

Perform the Test Setup.

Run the test to measure the % elongation percentage for your sample when stretched to 50.0N.

- Select L and D to zero Load and Distance.
- Select Set Home.
- Enter the Gage Length value. This is a manually entered value that is a function of the Ask prompt we created. The original gage length for the sample is 1.125 inches (**Note:** enter values only with no units of measure).
- Select the checkmark.

The calculated % elongation for this run for this sample is 74.756%.

4.0 Using I/O

All FMS testing frames feature an I/O connector located on the back of the machine column. When the Automation Builder software is installed, you have eight (8) programmable lines of digital I/O for use with external devices. Lines may be individually set up as either an input or output. There must always be at least one input line when using the Automation Builder software.

4.1 I/O Schematic

The schematic for the FMS testing frame I/O connector is shown below. Using the internal power supply (0-5 Vdc), the maximum allowable output current is 125 mA. If you use your own power supply (maximum 0-24 Vdc), the maximum output current is 300 mA.

Lines 1 is for customer supplied power up to 24 V. Line 2 is for the FMS power supply (5 V). Short lines 1 and 2 to use the FMS 5 V supply. Lines 11 and 12 are for grounds. Lines 3 through 10 may be configured for input or output with a wakeup as either High or Low. Input lines may be 5-24 V. Outputs are 5 V with the FMS power source or 24 V with a customer supply.

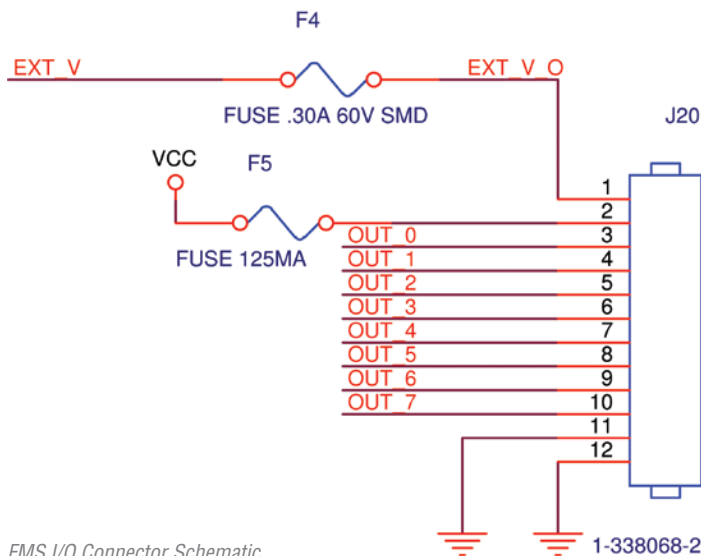

FMS I/O Connector Schematic

4.2 I/O Line Settings

Before I/O can be used, you must set up the I/O lines. Use the L2 Setting to access the I/O Lines option. Each configurable line has the following setup options: Line Name, Type and Wakeup Level.

You may name each I/O line. Line names may be up to 8 characters in length.

The Line Type may be either an Input or Output.

The Wakeup Level may be set as either a High (5 Vdc) or Low (0 Vdc).

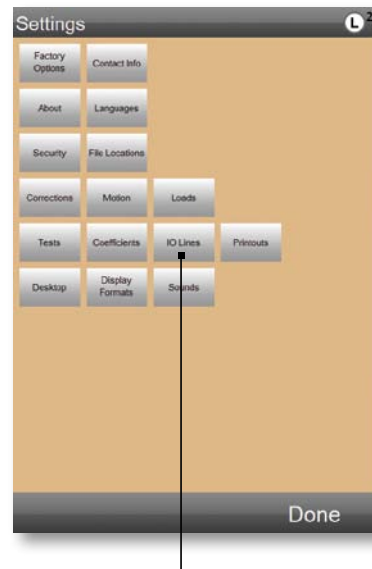

Select the IO Lines option to access the individual I/O line setup.

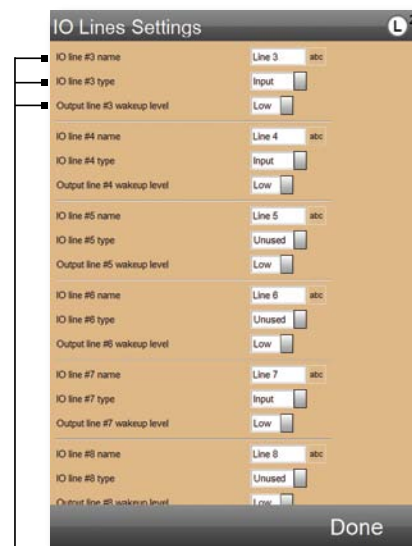

Configure lines 3 through 10. You must have one input line configured.

Specify a Line name (8 characters).

Specify Line as either an Input or Output.

Specify Line as either High (5 Vdc) or Low (0 Vdc).

4.3 Move to Inputs

The Tension, Compression and Hold steps each contain an I/O option. The I/O steps will display when an input is set up for one of your I/O lines. The I/O steps will not display if no I/O input line is configured.

IMPORTANT: The I/O steps will not display unless an input line is set up.

4.3.1 Using Tension/Pull Input

The Tension/Pull Step can be used to measure the load and distance when an event occurs that is measured by one of the FMS test frame's input I/O connectors. For example, if you wanted to determine the load and distance when an electrical switch is opened (pulled), you could use the tension/pull step. In this example, the electrical switch would be connected through the I/O ports. The crosshead moves upward until the switch is opened/closed. When the switch triggers an output, the crosshead stops and the load and distance at the event for the switch is measured and reported.

4.3.2 Using Compression/Push Input

The Compression/Push Step operates identically as the tension/pull steps except in the opposite direction. Use this when you are compressing a pushbutton switch, for example.

4.3.3 Using Hold Inputs

There are two types of Hold Steps that can use the I/O functions. There is a Hold Load and a Hold Distance. These steps are used in combination with either the Tension or Compression Steps. For example, you can set up a test to go to a load target and hold until a switch contact is made. Once the contact is detected, the test is completed and the results are reported.

We entered a tension step: go to a Load Limit of 20 N.



Because an input line is setup, the Tension I/O step is shown.

The load will be held at 20 N until input line 4 is closed. Once this event occurs, the line state goes High (5 V) and the test is concluded.

The Distance (D) at this event is reported.

When the input line called "Switch" closes, the Line State is Low (0V). The load and distance at that event will be reported and the test will conclude.

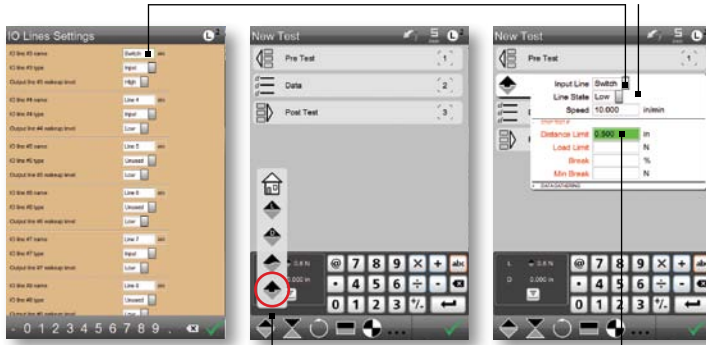

Because an input line is set up, the Tension I/O step is shown.

Included is a Distance Limit exception to prevent overtravel during the test.

4.4 Outputs

You may also set up a digital output for any of the I/O lines 3 through 10.

To use a digital output, select the Output Step and add it to your test setup. The Output Step has three attributes: Condition, Output Line and Line State.

An output line may be set up to transmit a digital output High (5-25 V) or Low (0 V) based on these conditions: Always, Tolerance Fail and Test Fail.

When the condition is set to Always, an output is always transmitted at the completion of the Output Step.

With the Condition set to Always, when a test is completed, a high output will be sent to Line 5.

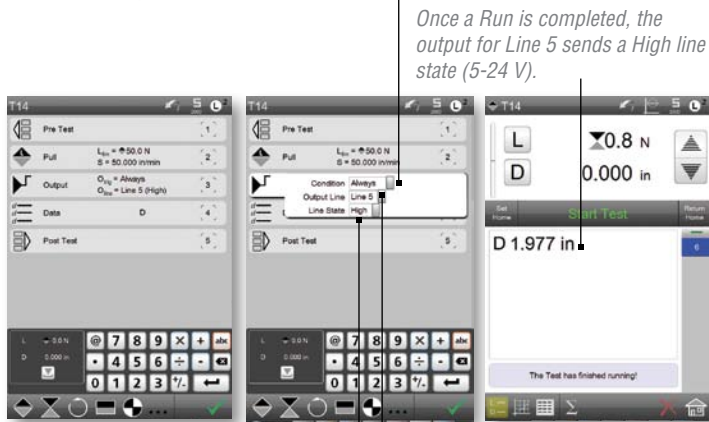

Once a Run is completed, the output for Line 5 sends a High line state (5-24 V).

Line 5 was set up as an Output Line. Use the main Settings menu and I/O Lines to set up Line 5.

When the condition is set to Tol Fail (Tolerance Fail), a digital output is transmitted to the assigned output line when one of your coefficients, which was set up with tolerance limits, fails. If the measured results for the coefficient fall outside the limit range defines the tolerance range, then the results are considered “failed” and the output is transmitted as either a High or Low signal.

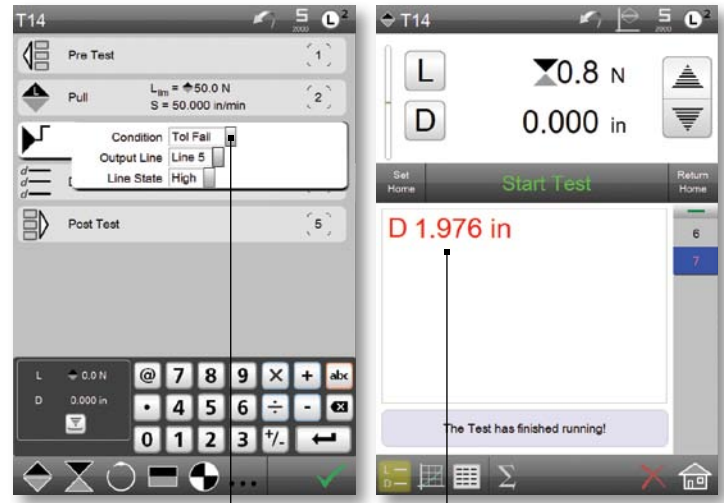

The Condition is set for a Tolerance Fail. When a tolerance is set up and the test results fall outside the tolerance range (Fail), Line 5 transmits a High (5-24 V) signal.

The test is completed.

The result is a fail (red) because the result value is outside the tolerance range set for this setup.

The Test Fail condition transmits an output when the test fails. A failed test may be caused by an exception condition that you set up for your test. In a load limit test, for example, where a distance limit exception was set up, the test will fail if the crosshead travels to the distance limit before the load limit target was achieved. Since the exception occurred, the test will abort and the test will fail. If the condition is set to Test Fail, then a digital output will be transmitted.

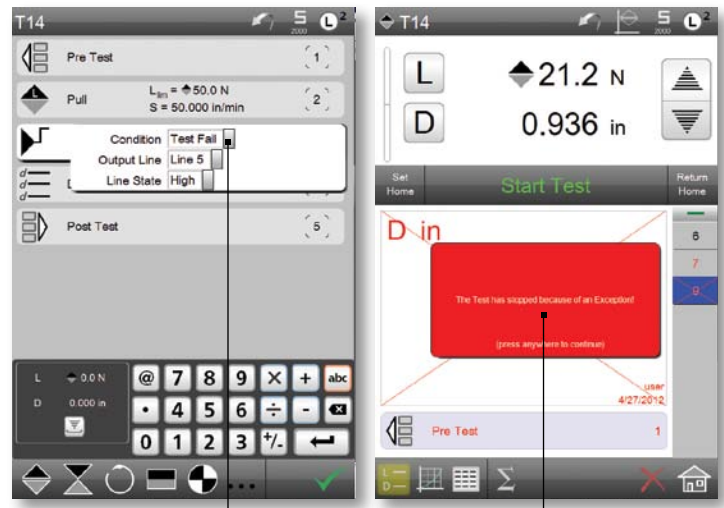

The Condition is set for a Test Fail. When the test fails, Line 5 will transmit a High (5-24 V) signal.

The test is aborted due to an exception. The test failed.

A failed test is caused by an exception assigned to a step within the setup.

5.0 Using Conditional Branching

Conditional branching uses logical statements to help automate your testing procedures. Use conditional branching to segregate passed/good parts from failed/bad parts in a conveyor system, as an example. Conditional branching may be used with your system's I/O to control ancillary equipment such as conveyors, solenoids, annunciators, etc.

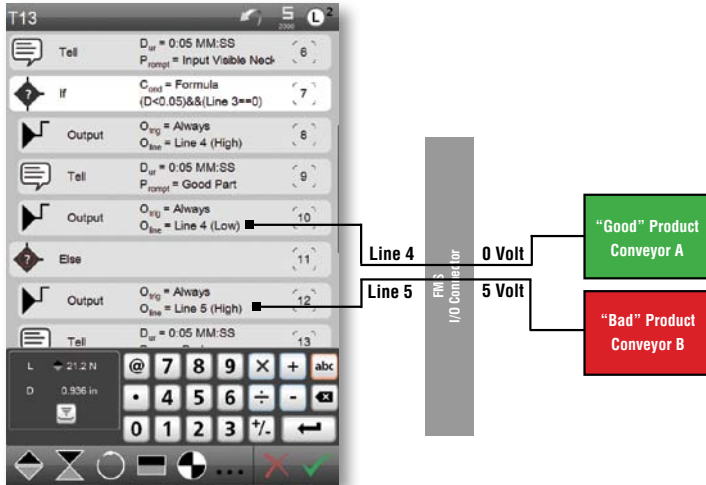

Using Conditional Branching, your measured results can direct product using factory automation. The FMS test system sends a digital output signal based on the measured result and criterion you establish. In this example, product is directed to one of two conveyor systems based on the measured result.

5.1 IF Step

The IF step is used when conditional branching is required for your application. The IF step uses a formula to evaluate measurements and determine what logical steps occur next based on these results. IF steps must occur in your set up after a step(s) has completed and where there is a measured result. An IF step cannot appear in your setup prior to a measured result taking place.



5.1.1 Formula Condition

When an IF step is used, always use the formula condition.

Formulas are created using coefficients, I/O lines and a set of logical operators. Before a formula can be created, the coefficients and I/O lines must have been set up for your test.

The logical operators that may be used are selected using the numeric keypad.

Operator	Description
(Start bracket, perform the order within the brackets first. Not used for multiplication
)	End bracket, <u>not used for multiplication</u> : incorrect (2)(2) versus correct 2 x 2
&&	Logical And
	Logical Or
!	Logical Not
>=	Greater than or equal to
>	Greater than
<=	Less than or equal to
<	Less than
!=	Not equal to
==	Equal to

5.1.2 True and False Conditions

Use the True and False conditions for debugging. These conditions should not be used in a test setup.

5.2 ELSE Step

The ELSE step is displayed when you have already selected an IF step in your setup. There are no setup options for the ELSE step. The ELSE step works in conjunction with the IF statement condition. When the IF statement is not true, the conditional branching will follow the branching when defined by the ELSE step.

5.3 END Step

The END step can be inserted anywhere in your test setup to end the test should an event occur. For example, suppose you had multiple load limit steps where the result of one of these steps would cause you to end the test, e.g. there is no reason to continue the test. You would place an END step after that particular load limit step. END steps are useful to prevent a test from continuing to run when a particular measurement or result occurs.

The End Step may be set up With Exception (YES) or Without Exception (NO).

For example, if during a conditional branching sequence there was a step that was determined to be an exception, e.g. $D > 2$, then you would end the test rather than allow the test to continue with no value to the operator.



Select an END step within your conditional branching sequence to end the sequence should an exception occur.

5.4 Conditional Branching Example

We will use the following test application to help describe how conditional branching may be used to automate your test application.

In this application, we are pulling an elastic material to a load limit of 50 N. We are measuring the material's length (distance "D") at the 50 N load limit target.

Prior to the test, we configured the I/O Lines using the main Settings menu where Line 4 and Line 5 are outputs, while Line 3 is an input line.

To begin, we are going to pre-stretch the material to 1N at a test speed of 5 inches per minute. At the completion of this step, we are going to zero both the Load (L) and Distance (D) values using a Datum step.

Next, we are going to pull the sample to 50 N at a test speed of 10 inches per minute. Then we are going to return to a 1N load position (crosshead will move downward). An ASK step will be used to prompt (tell) the operator by alerting the operator to whether or not any "necking" occurred in the sample while being stretched to 50 N. The operator does not enter any value to the ASK step. However, if necking was observed, the operator could stop the test by pressing the STOP TEST target.

Since no necking occurred, the test will continue. Now we can add our conditional branching.

We first insert an IF step. The IF step condition is based on the following formula:

If our distance (D) is less than 0.05 inches AND (&&) our Line 3 state is low (0).

When these two conditions are TRUE, the output signal at Line 4 changes from a High signal (5 V) to a Low signal (0 V). In this case, Line 4 is used to control a conveyor that directs "good" product through the automation process.

An ELSE step is used, however, to direct the outputs when the sample was determined to be bad. We enter an ELSE step.

If the distance (D) is greater than 0.05 inches or if our Line 3 stage is high, then the output signal at Line 5 changes from a High signal (5 V) to a Low signal (0 V). In this case, Line 5 is used to control a conveyor that directs "bad" product through the automation process, e.g. removes bad product from good product.

At the completion of the test, the crosshead returns to the Home position at 50 inches per minute.

This test setup uses an IF statement to set the outputs on the FMS connector.

An ELSE statement is used when the IF statement is not true.

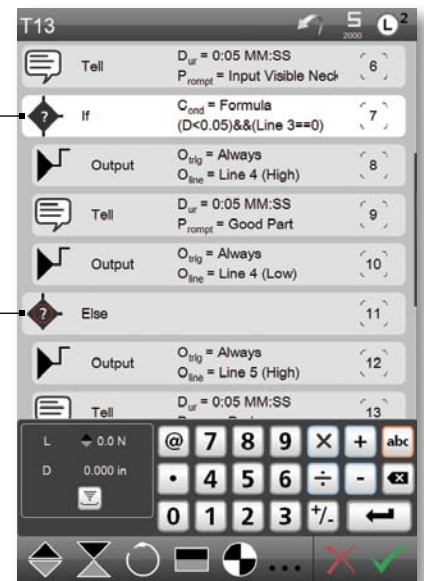

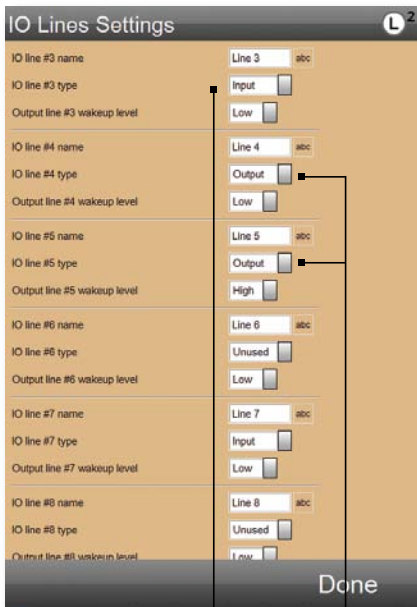

Set up Line 3 for Input. Set up Line 4 and 5 as Outputs.

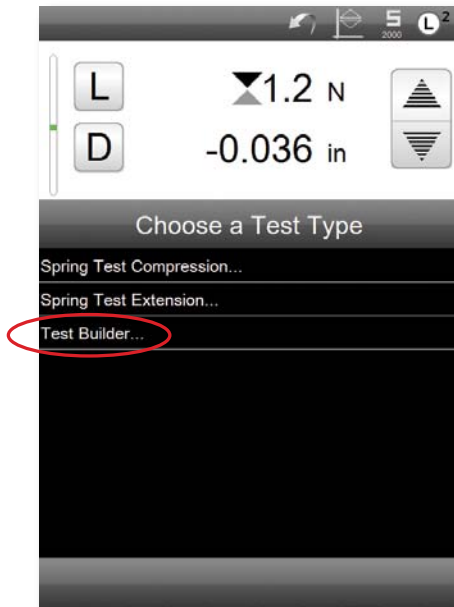

I/O Lines Setup

Before conditional branching can be used, you must set up your I/O lines.

- Go to IO Lines Settings using the main L2 Settings menu.
- Set up Line 3 as Input.
- Set up Lines 4 and 5 as Outputs.
- Select Done and return to the Main View.

Create a New Test

Use the Test Builder to create your new test setup.

- Select Test Builder.

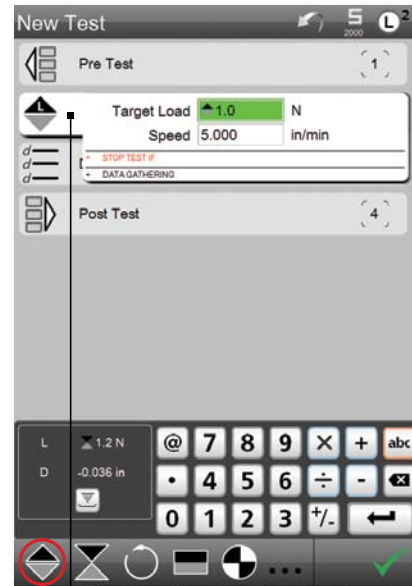

Add Tension Load Limit step.

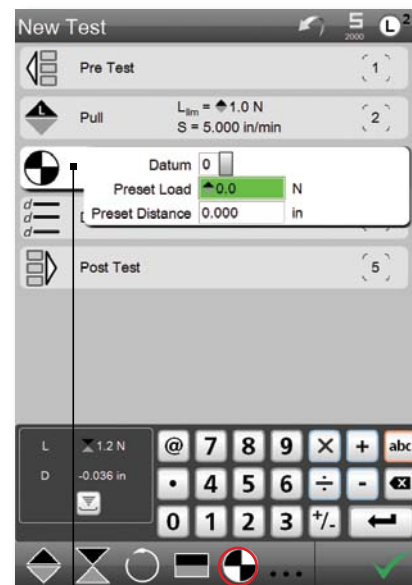

Add Datum step.

Initial Tension

Create an initial tension step to condition sample and compensate for deflection in the load string.

- Select Load Limit tension step.
- Enter small load target of 1.0 N. Specify test velocity 5 in/min.

Zero Load and Distance

Zero the Load (L) and Distance (D) values after initial tension.

- Add Datum step.
- Set Present Load to 0.0 N and Set Preset Distance to 0.000 in.



Add tension load step. | Select Distance (D) coefficient.

Test Tension

Create the sample's target tension load limit.

- Select Load Limit tension step.
- Enter sample's load target of 50.0N. Specify test velocity 10 in/min.

Select your Result (Coefficient)

Since we are using a load limit target, we want to determine the distance (D) the sample stretches to this limit.

- Select Data step.
- Choose Distance (D) from the list of coefficients. Make sure Distance (D) is associated with Step 4 (your test load target).



Return to Start Load

Create another load limit that returns the sample to a pre-tension load.

- Select Load Limit tension step.
- Enter sample's load target of 1.0N. Specify test velocity 10 in/min.



Change view to see the Ask Step.

- Select ... to view the Ask Step.

Add an Operator Prompt

Create a prompt for the operator to acknowledge the necking problem, if occurred.

- Select the Ask Step.
- Enter prompt- "Stop if Necking".
- Enter prompting Duration of 5 seconds.



Select Formula type.



Select Formula block.

Add IF Step.

- Select f(x) step and select IF type.

Use a Formula IF step.

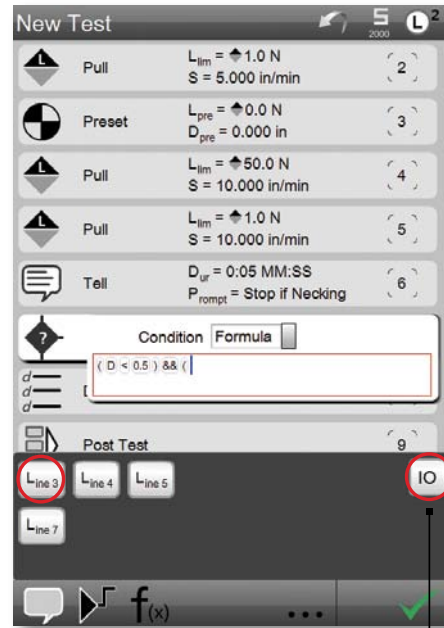

Navigate through the operators using the L,D and IO target.

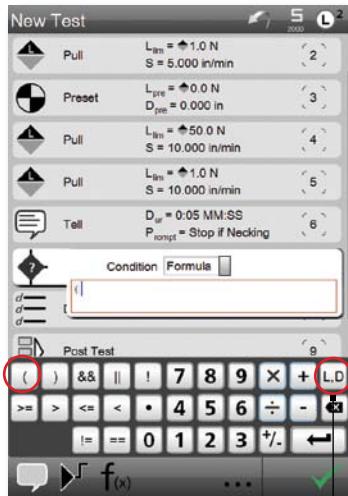

Navigate through the operators using the L,D and IO target.



Specify the formula type of IF step.

- Select Formula type.

Prepare your Formula.

Construct the formula for your IF step.

- Select the Formula block (turns red).

Create the formula that evaluates “if” the distance (D) is less than 0.5 inches.

- Select the “open” bracket.
- Enter the text D < 0.5.
- Select the ‘closed’ bracket.

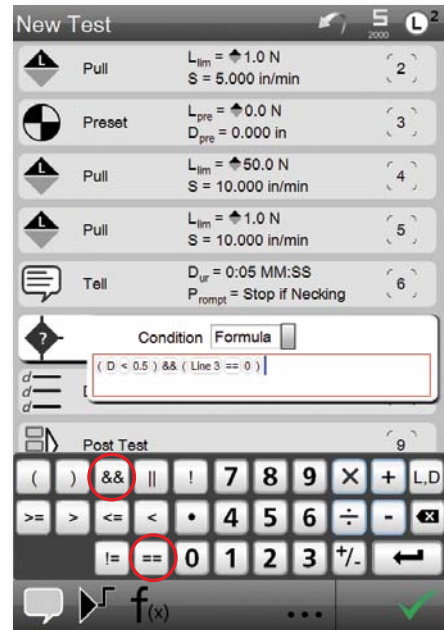

Add an ADD (&&) condition to your formula that evaluates the input Line 3. This line should be reading low (0).

- Select the “open” bracket.
- Select the Line 3 type using the IO view.
- Select the EQUAL operator and enter zero (0).
- Select the “closed” bracket.

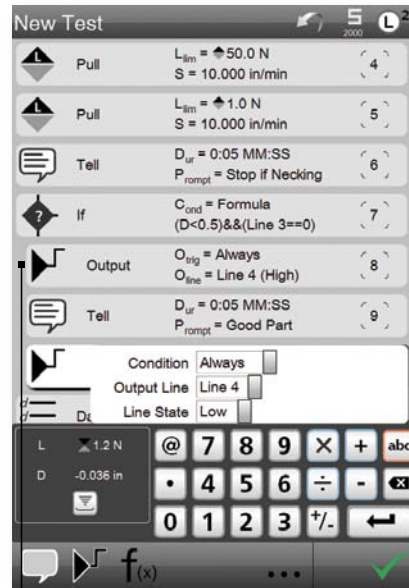
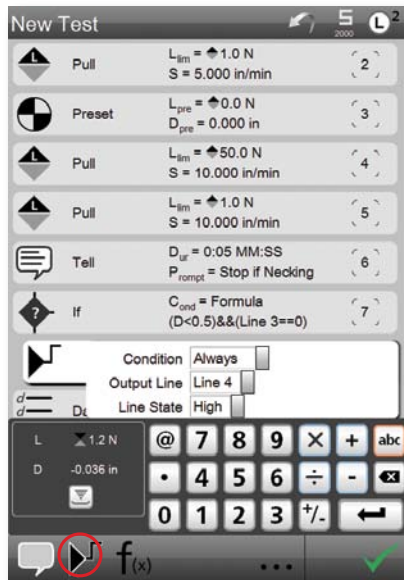

Notice that the steps after an IF step are indented to show they are sub steps for the IF step.



Enter the user prompt "Good Part".



Add an Output.

Create an output for your IF step. When the IF step is true perform this output function. In this example, we want Line 4 to be High (5 V).

- Select the Output step.
- Select the output Condition to Always for Line 4 and set the state High (5 V).

When the distance (D) is less than 0.5 inches, and, when Line 3 is Low (0 V), this sets Line 4 to High (5 V).

Add a User prompt.

When the IF step is true and the conditions are met, the part is good. Alert the user about a good part.

- Select the Ask step and select the Tell type. Enter the prompt- "Good Part".

Add another Output.

Create an output for your IF step. When the IF step is not true, perform this output function. In this example, we want Line 4 to be Low (0 V).

- Select the Output step.
- Select the output Condition to Always for Line 4 and set the State to Low (0 V).

Add an ELSE step.

Since an IF step was specified, you can now add an ELSE step.

- Select the f(x) step.
- Select the ELSE step.

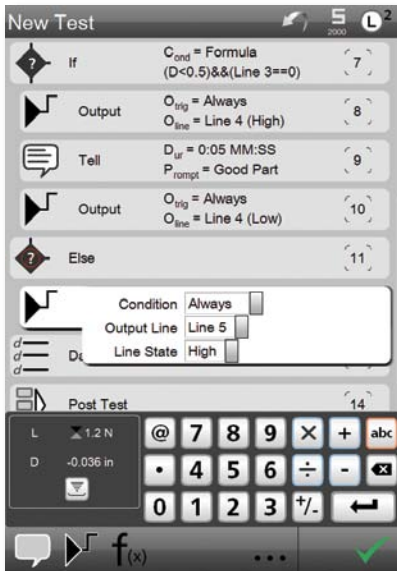
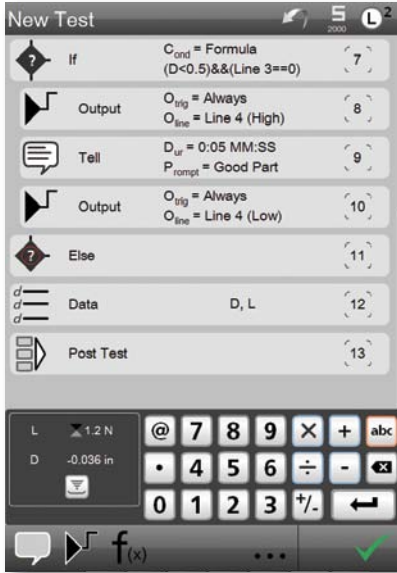

Add an ELSE step.

There are no configurable options for an ELSE step.

Add an Output step for the ELSE step.

Should the IF step not be true and an ELSE step is invoked, use another Output step to control your conditional branching for your output line 5.

- Select the Output step.
- Select the Condition type as Always. Specify Line 5 and set the state to High (5 V).

Add a User prompt.

When the IF step is true and the conditions are met, the part is good. Alert the user to a good part.

- Select the Ask step and select the Tell type. Enter the prompt- "Good Part".

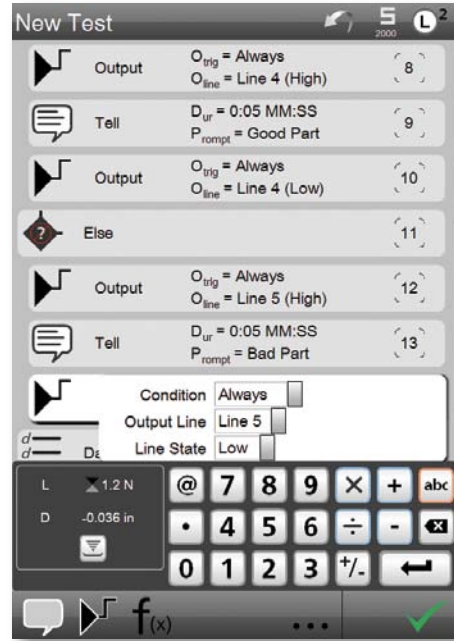
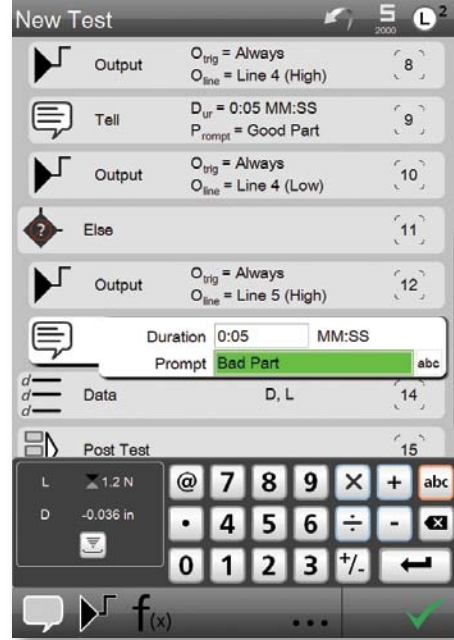

Add a User prompt.

When the ELSE step occurs, the part is bad. Alert the user about a bad part.

- Select the Ask step and select the Tell type. Enter the prompt- "Bad Part".

Add an Output step for the ELSE step.

When the ELSE step is invoked, use another Output step to control your conditional branching for your output line 5.

- Select the Output step.
- Select the Condition type as Always. Specify Line 5 and set the state to Low (0 V).

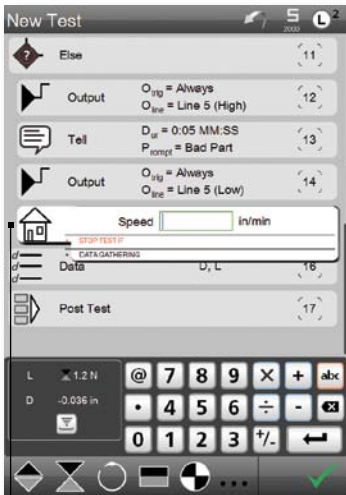

Note that your Go To Home Step is indented and part of the Else step.



Touch the Home step and drag the step to the left so that step 15 is no longer a substep of the Else step 11.

Add a Go To Home step.

At the completion of a test, tell the crosshead to Go To the Home position.

- Select the tension Home step. Specify the Go To Home velocity of 50 inch/min.

IMPORTANT

The Go To Home Step is inserted for the entire test.

When you enter the Go To Home Step, it is indented and looks to be part of the ELSE step. You need to change this and move the Go To Home so that it is part of the entire test setup.

- Select the left side of the Home step and “drag” the step so that it is no longer indented and part of the Else sequence.

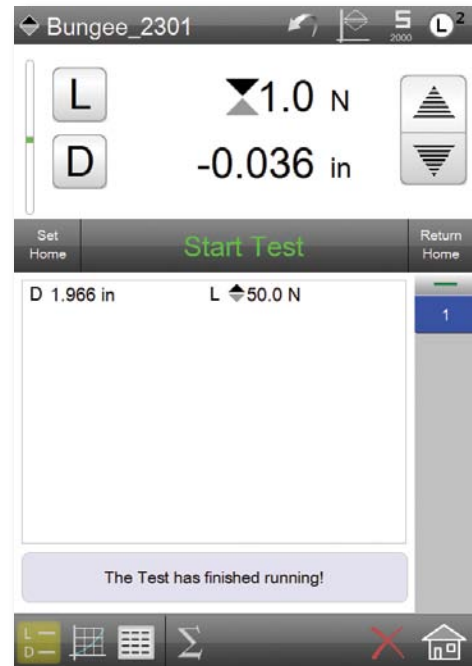
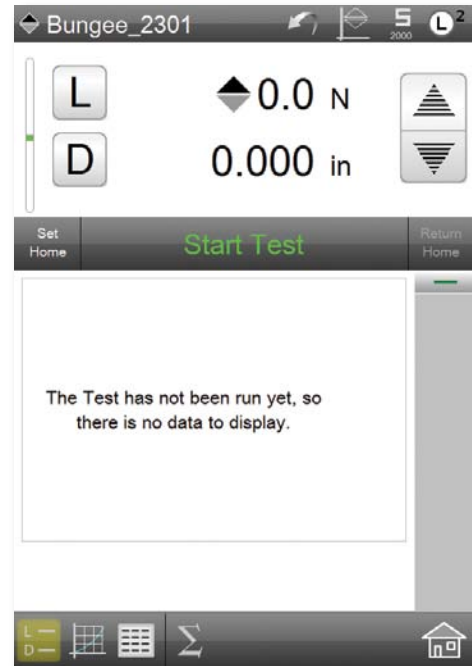

Start the test.

Zero Load (L) and Distance (D) by touching the L,D targets. Then set the Home position.

- Select the L to zero load.
- Select the D to zero distance.
- Select SET HOME to set the Home position where the crosshead starts.

When the test is completed, the results (coefficients) are displayed. Since the distance (D) is greater than 0.5 inches, the output for Line 5 went from High (5 V) to Low (0 V).



Corporate Headquarters

The L. S. Starrett Company
121 Crescent Street
Athol, MA 01331 USA
Tel: 978-249-3551

Starrett Metrology Division

Starrett Kinematic Engineering, Inc.
26052-103 Merit Circle
Laguna Hills, CA 92653 USA
Tel: 949-348-1213

Form 976 09/12 PDF

Specifications Subject to Change ©Copyright 2012 starrett.com